

# DHCON DRC Compact

## User manual



Your Digital Heroes.

**History**

<b>Revision</b>	<b>Date</b>	<b>Description/changes</b>	<b>Name</b>
R01	16/12/2022	Draft	SG
R01	16/12/2022	Review	MAD
R01	16/12/2022	Added new pictures of the device	SG
R01	19/12/2022	Review and release	MAD

Preliminary

**Dear customer,**

We are enthusiastic about technology – and have been for more than 25 years. It is our motivation to pave the way for the digital future with our solutions. It is our spirit of discovery that drives us to realize our vision of the future, thinking outside of the box.

We see ourselves as digital heroes who will find an individual solution for your problem together with you – also with this product.

Thank you for choosing us and thus a product containing innovative solutions down to the finest detail. So that you can use our product continuously and without problems, please read the user manual carefully and keep it for future consultation.

Should you still have a problem someday, please contact us.

We are here for you and happy to help.

We hope you enjoy using this product.

Your Digital Heroes.

# Contents

1	General product information .....	7
1.1	Product details .....	7
1.2	Scope of delivery.....	7
1.3	Manufacturer and customer service address .....	7
2	Product description .....	8
2.1	Overview.....	9
2.2	Technical specifications .....	9
2.2.1	Short description .....	9
2.2.2	Detailed information.....	10
3	Safety information .....	11
3.1	Graphic symbols for safety-related information .....	11
3.2	Activities according to user groups.....	11
3.3	Intended use .....	11
3.4	User group .....	12
3.5	Danger.....	12
3.6	Special precautionary measures.....	12
4	Prepare the use of the product.....	12
4.1	Transport and storage .....	12
4.2	Disposal of product and packaging material .....	12
4.3	Preparation of the installation.....	13
4.4	Setup .....	14
5	Operation.....	14
5.1	Interfaces .....	14
5.1.1	Power supply.....	14
5.1.2	RS485-1 .....	15
5.1.3	RS485-2 .....	15
5.1.4	RS232.....	15

---

5.1.5	CAN.....	15
5.1.6	Gbit Ethernet.....	16
5.1.7	100 Mbit Ethernet.....	16
5.1.8	USB Host.....	17
5.1.9	Micro SD card socket.....	17
5.1.10	WiFi/BT.....	17
5.1.11	Status LEDs.....	18
5.1.12	Debug Interface.....	18
5.2	Normal mode.....	20
5.3	Malfunction.....	20
6	Software documentation.....	21
6.1	System architecture.....	21
6.1.1	Boot loader U-Boot.....	21
6.1.2	Linux Kernel.....	21
6.1.3	Linux root file system.....	21
6.2	Linux boot process.....	22
6.2.1	Boot loader.....	22
6.2.2	Kernel.....	22
6.2.3	Root file system.....	22
6.3	Device access and login.....	23
6.3.1	Console via Debug Interface.....	23
6.3.2	Console via Ethernet.....	23
6.3.3	Web interface.....	24
6.4	Updates.....	24
6.5	Interfaces.....	24
6.5.1	RS485-1.....	24
6.5.2	RS485-2.....	24
6.5.3	RS232.....	24

---

6.5.4	CAN.....	25
6.5.5	USB Host.....	25
6.5.6	Status LEDs.....	25
6.5.7	WiFi.....	26
6.6	Implementing applications of your own.....	26
7	Maintenance.....	26
8	Decommissioning, disassembly, disposal.....	27
9	Order information.....	28
10	Customer-specific changes.....	28

Preliminary

# 1 General product information

## 1.1 Product details

With the DRC Compact, you have chosen a product of the DHCON series. Our DHCON products are optimized for smart home and building as well as Industry 4.0 and IoT applications. The DHCON DRC Compact is a universally usable computer for control and connectivity tasks and is characterized by highest flexibility combined with low energy consumption and an availability of at least ten years.

To guarantee a long-term, error-free service life, this manual has to be read before use and be at hand for future consultation. You can find further useful information, documents, and software on

<https://www.dh-electronics.com/en/>.

<b>Product name</b>	<b>DHCON DRC Compact</b>
<b>Product revision</b>	R01
<b>Product version</b>	DH standard
<b>Manufacturer</b>	DH electronics GmbH

## 1.2 Scope of delivery

The following listing gives an overview of the components included in the delivery.

- Short instructions
- DIN rail controller DRC Compact

## 1.3 Manufacturer and customer service address

We do our best to provide you with all necessary information about our products. Should you however not be able to solve a problem with the user manual and the documents on our website, we are happy to help. Please feel free to contact one of our employees.

- Via our website: <https://www.dh-electronics.com/en/contact-form>
- Via e-mail: [sales@dh-electronics.com](mailto:sales@dh-electronics.com)
- Via phone: +49 8662 4882 0
- Via mail: DH electronics GmbH, Am Anger 8, 83346 Bergen, Germany

## 2 Product description

The DHCON DRC Compact is a universally usable computer for control and connectivity tasks and can be used as gateway, router, or soft-PLC due to its variety of industrial interfaces. Due to its compact and robust design, it fits perfect to industrial surroundings. The DRC Compact controller differs from other available devices due to two special features:

- Modular communication interface extensions

It is possible to choose between the second RS485 interface or RS232 interface or CAN.

Depending on the chosen configuration the board has one of the three interfaces above available.

- Optional WiFi/BT connectivity

A configuration of the DRC Compact with WiFi/BT connectivity is also available. The device is fully certified and supports all of the needed standards.

Preliminary



## 2.1 Overview

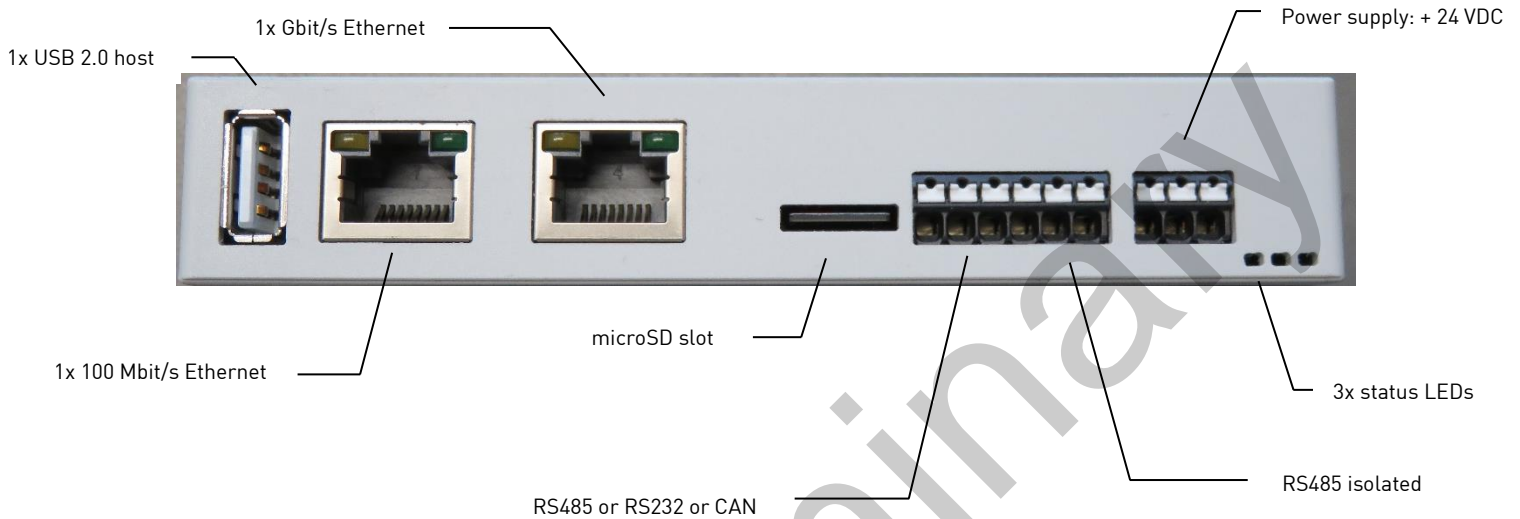

## 2.2 Technical specifications

### 2.2.1 Short description





Input voltage	10,8 to 26,4 VDC
Input current	2.5 A (max.)
Power consumption	4 W (typ.)
Operating temperature	0 bis +50 °C
Storage temperature	-20 bis +70 °C
Protection class	IP 30
Dimensions length x width x height	128 x 17,5 x 94,2 mm
Weight	120 g

## 2.2.2 Detailed information

<b>CPU</b>	
Type	DHCOR STM32MP157
Frequency	650 MHz
RTC	Yes, battery-backed CR1220 or internal capacitor
<b>Memory</b>	
RAM	512 MB
eMMC Flash	8 GB
Mirco SD card slot	Up to 64GB
<b>Interfaces</b>	
Ethernet	1 x 10/100 Mbit/s 1 x 10/100/1000 Mbit/s
Serial COM	1 x RS485 isolated 1 x RS485 or RS232 non-isolated
CAN	1 x up to 1 Mbit/s non-isolated (instead of second serial interface)
USB 2.0	1 x USB Host 2.0
LEDs	3 x status LEDs (2 x user defined)
Debug interface	Internal TTL UART
<b>Wireless interfaces</b>	
Bluetooth	Bluetooth v4.2 (BR/EDR/BLE)
WiFi	WiFi 5 GHz & 2,4GHz IEEE 802.11a/b/g /n/ac
Antenna	Internal PCB antenna

## 3 Safety information

### 3.1 Graphic symbols for safety-related information

Symbol	Category	Description
	Mandatory sign	Ground before use
	Prohibition sign	General prohibition sign
	Warning sign	General warning sign
	Warning sign	Warning of electric voltage

### 3.2 Activities according to user groups

Activity	Layperson	Trained specialists	Technical sales employee
Unpacking and setup		X	
Connection and launch		X	
Operation		X	
Troubleshooting			X
Maintenance			X
Disassembly		X	
Disposal		X	

### 3.3 Intended use

The DHCON DRC Compact is a universally usable computer for control and connectivity tasks. The device may only be used in indoor applications. Any deviating use is not intended and can lead to malfunctions. Information on the secure operation and maintenance can be found in the respective chapters. Please contact us in case of any problem that you cannot solve yourself.

## 3.4 User group

The device may only be used by trained specialists. The specialists can carry out the tasks mentioned in Chapter 3.2 independently. In case of failures and for maintenance tasks, please contact a technical sales employee.

## 3.5 Danger

Inappropriate use of the device can lead to damage of objects or the injury of people. Therefore, please make sure to bear in mind the safety instructions included in the user manual and do not deviate from the recommended measures, especially regarding commissioning and decommissioning, maintenance, or in case of failure.

## 3.6 Special precautionary measures

If you comply with the precautionary measures contained in the user manual and take into account warning and safety indications, you should be able to operate the device without problems. Should you ever be under the impression that a secure operation cannot be guaranteed, disconnect the device from the power supply as quickly as possible and contact a technical sales employee.

# 4 Prepare the use of the product

The following paragraph describes the correct approach before the actual use of the product.

## 4.1 Transport and storage





All products of DH electronics are delivered in professional packing. In any case, the products are protected from vibrations; if necessary, a special ESD packaging is used. Our products may only be transported and stored in the provided original packaging, as only then can a high product quality be guaranteed for a longer transport or storage period. The scope of delivery should be controlled when the product is unpacked; afterwards, the packaging has to be disposed appropriately. The customer is responsible for this.

## 4.2 Disposal of product and packaging material

Packaging material always has to be disposed appropriately by the customer. In addition, he is responsible for disposing of the delivered product after termination of use at his own expense according to legal regulations. The customer indemnifies DH electronics GmbH from the take-back obligation and related third-party claims. Should the product be passed on to third parties, the customer must instruct these third parties by contract regarding taking over the duty of disposal and reiterating this duty. Should the customer refrain from doing so, he is obliged to take the delivered product back after termination of use at his own expense and to dispose of it according to legal regulations.

## 4.3 Preparation of the installation

### Safety information

	<ul style="list-style-type: none"> <li>▪ In electric systems, voltages can occur that are dangerous for people. When live parts are touched, this can lead to an electric shock.</li> <li>▪ Make sure that the device is disconnected from the power supply.</li> <li>▪ <b><i>Do not supply the device via an alternating current network.</i></b></li> </ul>
	<ul style="list-style-type: none"> <li>▪ The device has to be grounded before use.</li> </ul>
	<ul style="list-style-type: none"> <li>▪ Do not drop the device.</li> <li>▪ Make sure that the ventilation slits of the housing are not covered and bear below installation instructions in mind!</li> </ul>
	<ul style="list-style-type: none"> <li>▪ The device must not be operated in inflammable or explosive surroundings.</li> </ul>

### Installation instructions

The device is clipped into a DIN rail by means of a clip on the bottom of the housing. For this purpose, put the device onto the side opposite the clip and then push it down. The device may only be installed horizontally; a deviating installation is not permitted.

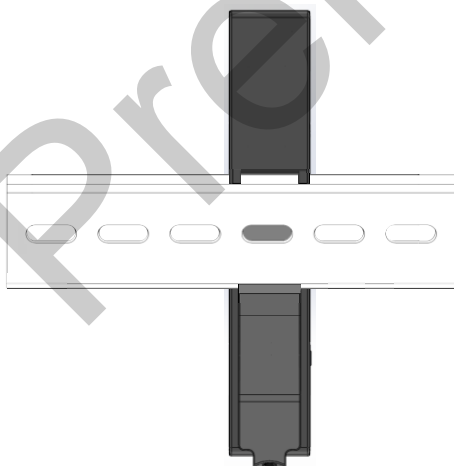

*Installation on the DIN rail (rear view)*

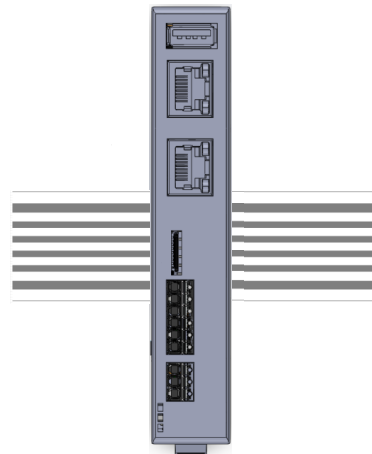

*Horizontal installation position (front view)*

## 4.4 Setup

The device is delivered in an operational condition. For setting up the device, proceed as described in the following paragraph and bear in mind the safety instructions from Chapter 3.

- Make sure that the power supply on the customer side is switched off at first.
- Put the device into the DIN rail (see Chapter 4.3).
- The device has to be grounded before use. For that purpose, connect X1  $\perp$  with the protective conductor. For the power supply of the device, use a +12/+24 VDC power supply unit.

***Do not supply the device with alternating voltage.***

- Connect the negative lead of the power supply with X1-GND.
- Connect the positive lead of the power supply with X1-24 V.
- Switch on the supply voltage.
- The device will boot automatically.

## 5 Operation

Bear in mind the safety instructions from Chapter 3 and the instructions for setup from Chapter 4.4. To guarantee a secure operation, the device must only be used by trained staff according to Chapter 3.2.

### 5.1 Interfaces

The device contains various interfaces, which are listed and described briefly in the following.

#### 5.1.1 Power supply

- The device is supplied via a power supply unit with +10,8 to 26,4 VDC; for this a pin header with 3 poles is used. A supply with alternating voltage is not permitted.
- Input voltage is protected against polarity reversal, the input current is limited to 2,5 A.
- The current limit is carried out by a 2,5 A fuse. Should you suspect it to have blown, please contact us immediately.

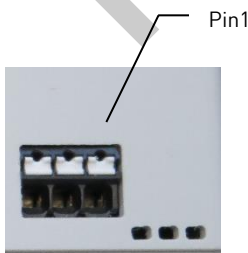

Terminal	Pin	Name	Description
X1	Pin1	24 V	Input voltage
X1	Pin2	GND	Input ground
X1	Pin3	$\perp$	Ground connection *)

**\*) For a fault-free operation, the ground connection must be connected according to regulations!**

### 5.1.2 RS485-1

The RS485-1 interface is connected via a 6-pin header and is isolated (2,500 Vrms) from all other interfaces.

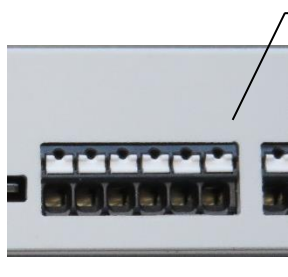

Terminal	Pin	Name	Description
X2	Pin1	RS485-1-A	Positive RS485 signal
X2	Pin2	RS485-1-B	Negative RS485 signal
X2	Pin3	GND_ISO	Isolated mass

### 5.1.3 RS485-2

The RS485-2 interface is – if the RS485 board configuration is in use - connected via the same 6-pin header as the RS485-1 interface.

**CAUTION: This interface is not isolated**

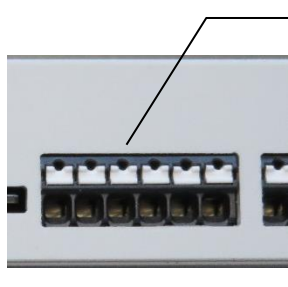

Terminal	Pin	Name	Description
X2	Pin4	RS485-2-A	Positive RS485 signal
X2	Pin5	RS485-2-B	Negative RS485 signal
X2	Pin6	GND	mass

### 5.1.4 RS232

The RS232 interface is – if the RS232 board configuration is in use - connected via the same 6-pin header as the RS485-1 interface.

**CAUTION: This interface is not isolated**

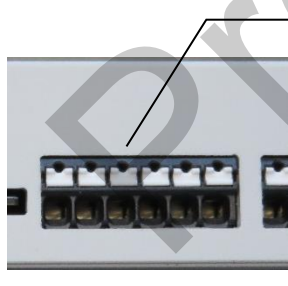

Terminal	Pin	Name	Description
X2	Pin4	RS232-TX	RS232 transmit signal
X2	Pin5	RS232-RX	RS232 receive signal
X2	Pin6	GND	mass

### 5.1.5 CAN

The CAN interface is – if the CAN board configuration is in use - connected via the same 6-pin header as the RS485-1 interface.

**CAUTION: This interface is not isolated**

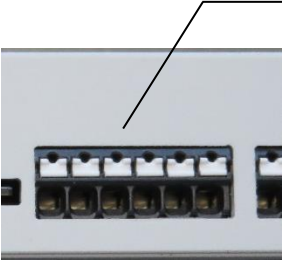

Terminal	Pin	Name	Description
X2	Pin4	CAN-H	CAN high signal
X2	Pin5	CAN-l	CAN low signal
X2	Pin6	GND	mass

### 5.1.6 Gbit Ethernet

The device offers the possibility to connect two separate Ethernet networks. One interface supports networks with up to 1000 Mbit/s. In addition, transmitting and receiving lines are recognized automatically via Auto MDI-X, so that both crossed and uncrossed patch cables can be used. The RJ45 sockets are allocated according to Ethernet standard.

#### LED state:

The green LED is on when a 1Gbit connection is established.

The green LED is blinking while data transfer in a 1Gbit connection.

The orange LED is on when a 100Mbit connection is established.

The orange LED is blinking while data transfer in a 100Mbit connection.

The green and orange LED are on when a 10Mbit connection is established.

The green orange LED are blinking while data transfer in a 10Mbit connection.



### 5.1.7 100 Mbit Ethernet

The device offers the possibility to connect two separate Ethernet networks. One interface supports networks with up to 100 Mbit/s. In addition, transmitting and receiving lines are recognized automatically via Auto MDI-X,



so that both crossed and uncrossed patch cables can be used. The RJ45 sockets are allocated according to Ethernet standard and have a green LINK LED and a yellow SPEED LED. The blinking speed of the green LED stands for the data transmission rate. The yellow LED lights up when the data transmission takes place with a network speed of 100 Mbit/s. If the yellow LED does not light up, the network speed is 10 Mbit/s.

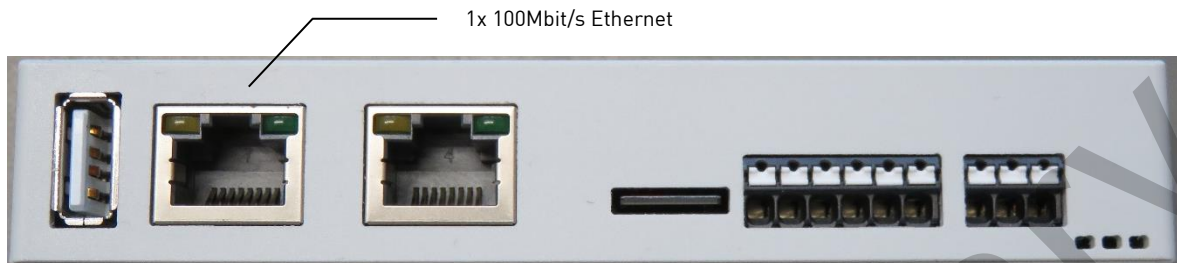

### 5.1.8 USB Host

The device has one USB 2.0 host interface.

The assignment of the socket corresponds to the USB 2.0 standard.

### 5.1.9 Micro SD card socket

The device is equipped with an microSD card slot.

The assignment of the socket corresponds to the micro SD card specification



### 5.1.10 WiFi/BT

The device offers the possibility to connect to WiFi networks and establish a Bluetooth connection.

The DRC Compact supports WiFi 5 GHz and 2,4 GHz and fulfils the standard IEEE 802.11a / b / g / n / ac.

The DRC Compact supports Bluetooth 4.2 (BR/EDR/BLE)

The device uses an internal PCB antenna for bringing up the WiFi and BT connection.

### 5.1.11 Status LEDs

The device has 3 status LEDs.

The green LED is on when the board is powered with the supported voltage.

The red LED is controlled via GPIO and can be configured by the customer.

The yellow LED is controlled via GPIO and can be configured by the customer.



### 5.1.12 Debug Interface

The DRC Compact supports an internal debug interface. If the front bezel is removed there can be find a 3 pin header which is connected to the console of the device.

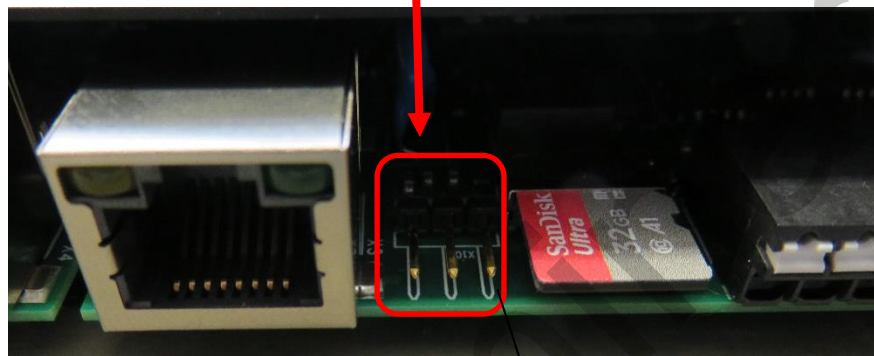
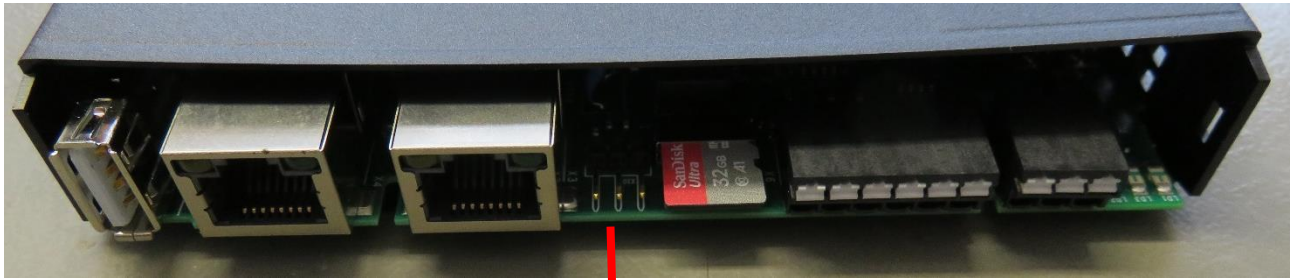

Pin1

Terminal	Pin	Name	Description
Debug	Pin1	TX	Console transmit
Debug	Pin2	RX	Console receive
Debug	Pin3	GND	mass

With this interface it is possible to have access to the CPU via the console.

For the use of a terminal program (Tera Term, Putty), the following settings apply:

- Baud rate: 115,200 bit/s
- Data bits: 8 bit
- Parity bits: none
- Stop bits: 1 bit
- Flow control: deactivated

## 5.2 Normal mode

After the wiring has been locked, the device can be connected to the input voltage.

The functionality depends on the specific programming.

## 5.3 Malfunction

The procedure in case of a malfunction depends on the software. A description will follow shortly.

Preliminary

## 6 Software documentation

The following chapter describes the software-based installation and the operating options of the DRC Compact. As there tend to be a lot of changes, especially in the software area, we refer to the [DH Wiki](#) several times. Here you can find up-to-date information on all software-related matters. Information on the software DHCOR STM32MP1 that can be found in the Wiki is generally also valid for DHCON DRC Compact. You can find answers to frequent questions about Bootloader and Linux at > DHCOM >FAQ >General.

### 6.1 System architecture

The following illustration describes the software's system architecture.



#### 6.1.1 Boot loader U-Boot

The DHSOM-based embedded systems of DH electronics use the U-Boot boot loader (U-Boot stands for universal boot loader) as the software can run on different processors and microcontrollers. This allows for flexible configuration possibilities during the compiling.

Download; [DH Wiki](#) > DHCOR STM32MP1-LG

#### 6.1.2 Linux Kernel

After executing the boot loader software, the boot loader loads the Linux Kernel.

Download: [DH Wiki](#) > DHCOR STM32MP1-LG

#### 6.1.3 Linux root file system

The root file system has to be installed as basis for all further directories. Actual a Linux YOCTO system is in use.

Download: [DH Wiki](#) > DHCOR STM32MP1-LG

## 6.2 Linux boot process

### 6.2.1 Boot loader

DHCOR products use U-Boot as boot loader. Important steps for accessing the boot loader console:

1. Remove the front bezel and connect the Debug port with a TTL interface of your host (TTL RS232 voltage)
2. For the use of a terminal program (Tera Term, Putty), the following settings apply:
  - Baud rate: 115,200 bit/s
  - Data bits: 8 bit
  - Parity bits: none
  - Stop bits: 1 bit
  - Flow control: deactivated
3. Press the "Del" key during the start of the module to call up the boot loader console. Further information on U-Boot (recovery, console commands, updates, display and hardware settings, build process) are available in the [DH Wiki](#).

### 6.2.2 Kernel

In the [DH Wiki](#) you can find information on the following topics at DHCOR STM32MP1-LG

### 6.2.3 Root file system

In the [DH Wiki](#) you can find information on using the Yocto root file system at DHCOR STM32MP1-LG. The commands for login, shutdown, and display calibration are especially important.

Login	Shutdown
DH Linux Distribution 4.0.0 dh-stm32mp1-dhcor-drc-compact ttySTM0 Dhcom login: root Password not needed	# shutdown -h now

In addition, a root file system can be created on a microSD card. Necessary steps are described in the [DH Wiki](#)

## 6.3 Device access and login

There are several possibilities to access the device. These are briefly described in the following. Generally, both emulation programs such as Tera Term or Putty and a Linux Shell can be used for the communication between Desktop PC and embedded system.

### 6.3.1 Console via Debug Interface

First, remove the front bezel and connect to the debug interface. Then connect the device to the power supply as described in Chapter 5.1. Also connect the COM port of your PC with the TTL-RS232 interface of the device via a cable. Then, you can access the embedded system via the emulation program. Subsequently, you can establish a connection via Putty. For that, carry out the following steps:

- Identify serial or USB serial port (COMx), e.g., via Windows Device Manager
- Select serial connection, corresponding COM port
- Baud rate 115,200 bit/s
- Activate the console via Enter
- Call up the boot loader console via the "Del" key
- DHCOS login: root
- root@dhcom: ~# here, commands for customer-specific programming can be entered

### 6.3.2 Console via Ethernet

First, connect the device to the power supply as described in Chapter 5.1.1. Connect one of the two Ethernet ports of the device with the Ethernet port in the network. Then, identify the IP address of the device, then establish a connection via SSH.

Afterwards, you can establish an SSH connection via Putty in a new terminal. Here, enter root@ip-address (e.g., root@10.64.1.137); alternatively, you can also just enter the IP address and have to confirm that you really want to establish a connection and are asked for the following login.

Login as: root

root@dhcom: ~# here, commands for customer-specific programming can be entered

### 6.3.3 Web interface

Shortly, you will be able to access and configure the device via a Web interface.

## 6.4 Updates

As the device contains modules from the DHSOM series, the information on the DHSOM update mechanism described in the [DH Wiki](#) applies here. In addition to the entire image, it is possible to update only parts of the system, such as the Linux Kernel. For this, only the boot loader must be executable, a running operating system is usually not necessary.

Note for updates via USB stick: We recommend using a USB stick partitioned via MBR and formatted with FAT32 with at least 1 GB memory as update medium.

## 6.5 Interfaces

The available interfaces of the device were already described in Chapter 5.1. Analogous to the description above, this section describes the interfaces of the software. You can find further information on the computer modules applied and the interface addressing in the [DH Wiki](#).

### 6.5.1 RS485-1

Control RS485-2 with the command `/dev/ttySTM1`.

Set the RS485 Flags to 0x03

→ RS485 Enabled

### 6.5.2 RS485-2

Control RS485-2 with the command `/dev/ttySTM2`.

Set the RS485 Flags to 0x03

→ RS485 Enabled

### 6.5.3 RS232

Control RS232 with the command `/dev/ttySTM2`.



## 6.5.4 CAN

This interface is initialized and tested as follows:

Operation	Code
Initialize	<code>ip link set can0 up type can bitrate 500000</code>
Send test message	<code>cansend can0 100#11.2233.44556677.88</code>
Receive test message	<code>candump can0</code>

## 6.5.5 USB Host

In the Linux Kernel used only USB devices of the type mass memory, i.e., USB memory sticks, are supported.

The following data systems can be used with the system:

- ext2 / ext3
- FAT32

Software updates can be imported via a USB stick. In addition, application data can be imported and exported.

## 6.5.6 Status LEDs

The two user defined LEDs can be controlled as follows:

Red LED	Code
Turn on	<code>Echo 255 &gt;/sys/devices/plat- form/led/leds/red:user1/brightness</code>
Turn off	<code>Echo 0 &gt;/sys/devices/plat- form/led/leds/red:user1/brightness</code>

Red yellow	Code
Turn on	<code>Echo 255 &gt;/sys/devices/platform/led/leds/yel- low:user1/brightness</code>
Turn off	<code>Echo 0 &gt;/sys/devices/platform/led/leds/yel- low:user1/brightness</code>

## 6.5.7 WiFi

Bring up the WiFi connection with the following commands:

Description	Code
Turn on WiFi	<code>ifconfig wlan0 up</code>
Set SSID and password of WiFi network to connect to	<code>wpa_passphrase [SSID] [password] &gt; wpa_supplicant.conf</code>
Connect to WiFi	<code>wpa_supplicant -B -Dnl80211 -iwlan0 -cwpa_supplicant.conf</code>
Get IP address	<code>udhcpc -i wlan0</code>

## 6.6 Implementing applications of your own

After the start-up of the device and the described login, you can implement applications of your own on the device. For that, we recommend the Virtual Machine for Application Development, which you can download in the [DH Wiki](#). The necessary commands for the specification of Linux as well as the Kernel user space interfaces for the access to the hardware are also described in the Wiki.

This and further information can also be found in the [DH Wiki](#).

Currently, we also have example applications, which we are happy to provide you with upon request.

## 7 Maintenance

The product's long service life can only be guaranteed if it is maintained properly. Only use a damp cloth to clean the device. Clean the product regularly. Disconnect the device from the power supply to avoid accidental deployment.

## 8 Decommissioning, disassembly, disposal

The decommissioning of the device takes place step by step and will be explained briefly in the following.

- Save all relevant data and shut down the system.
- Disconnect the device from the power supply.
- Remove all connections from the device.
- Take the device out of the DIN rail. For this, please pay attention to the following illustration.

To take the device out of the DIN rail, pull down the clip on the bottom of the device with a screwdriver. Now you can release the rail out of the DIN rail, first on the bottom, then on the top.

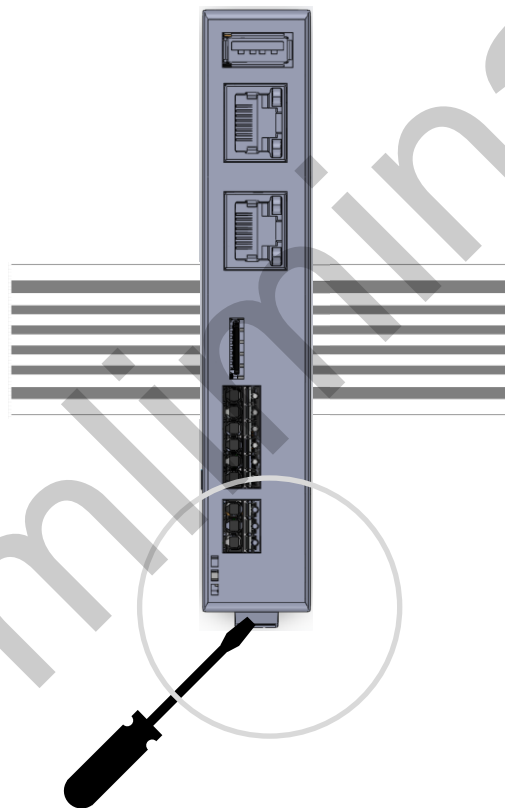

*To dismantle the DIN rail – pull down clip*

Use the original packaging for transport and temporary storage. As customer, you are obliged to dispose of the device appropriately. Therefore, please be aware of the guidelines mentioned in Chapters 4.1 and 4.2 in case of disposal. The device or parts of it might be able to be recycled.

## 9 Order information

Should you require components of the device, please contact our sales department. In exceptional cases, components cannot be reordered separately.

## 10 Customer-specific changes

With larger quantities, a customer-specific design for the front panel can be designed and printed upon request. If you are interested, please feel free to contact one of our sales employees.

### **DH electronics GmbH**

Am Anger 8

83346 Bergen

Germany

<https://www.dh-electronics.com/en/>

© 2022 DH electronics GmbH. All rights reserved.

The copyright of this document remains with DH electronics GmbH. This documentation contains technical information, which might not be changed, copied, reproduced, sold, rented, amended, or used in any other way without prior written consent of DH electronics GmbH.